

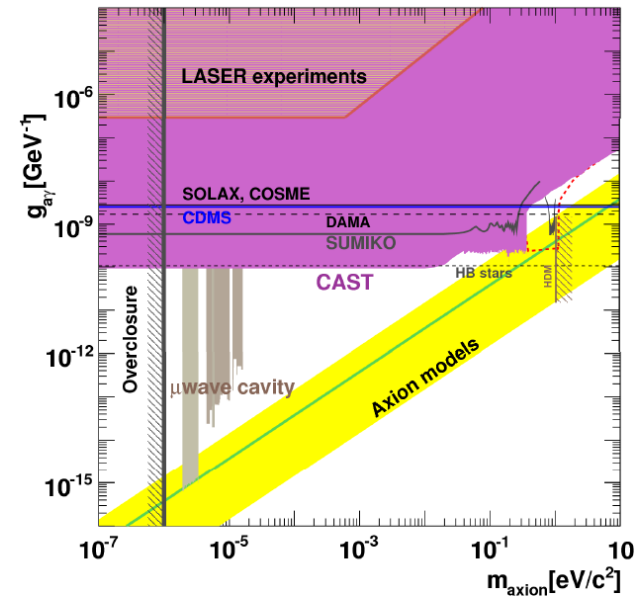

# The CAST experiment: status and perspectives



Esther Ferrer Ribas  
on behalf of the CAST Collaboration

ICHEP 2010-Palais de Congres (Paris)  
24<sup>th</sup> July 2010

# Motivation for Axions

- CP violation is necessary in the SM → matter-antimatter asymmetry
- CP violation observed in the weak interactions
- QCD predicts violation in the strong interactions

$$\mathcal{L}_\theta = \frac{g^2 \bar{\theta}}{32\pi^2} G_{\mu\nu}^\alpha \tilde{G}^{\alpha\mu\nu} \quad \text{with} \quad \bar{\theta} = \theta + \text{Arg}(\det M)$$

- However no experiment has observed this violation of CP in QCD!

- A possible solution to the strong CP-problem
- Elimination of CP-violating term in QCD Lagrangian by introduction of new additional global U(1) symmetry

$$\mathcal{L}_a = \left( \bar{\theta} - \frac{a(x)}{f_a} \right) \frac{1}{f_a} \frac{g}{8\pi} G_a^{\mu\nu} \tilde{G}_{a\mu\nu}$$

- New pseudo-scalar field : **AXION**
- First proposed by Peccei & Quinn (1977)
- Particle interpretation by Weinberg, Wilczek (1978)

# Axion properties

- Neutral Pseudoscalar

- Practically stable

- Very low mass  $m_a \simeq 0.6 \text{ eV} \frac{10^7 \text{ GeV}}{f_a}$

- Very low cross-section

- Coupling to photons

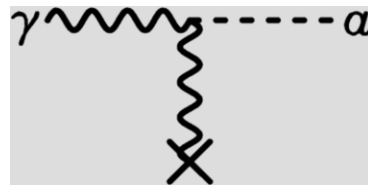

$$L_{a\gamma\gamma} = g_{a\gamma\gamma} (\vec{\mathbf{E}} \cdot \vec{\mathbf{B}}) a$$

- Possible dark matter candidates

# Principle of the helioscope



Production of axions

Detection of axions

Photons of blackbody radiation (X-rays photons)  
 → (strong EM fields in the solar core)  
 axions

Axions  
 → (strong magnetic field in lab.)  
 X-ray photons

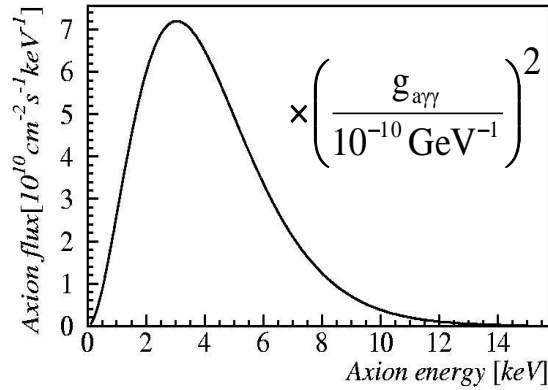

$$N_\gamma = \Phi_a \cdot A \cdot P_{a \rightarrow \gamma}$$

$$P_{a \rightarrow \gamma} = 1.7 \times 10^{-17} \left( \frac{B \cdot L}{9.0T \cdot 9.3m} \right)^2 \left( \frac{g_{a\gamma\gamma}}{10^{-10} \text{GeV}^{-1}} \right)^2$$

≈ 0.3 evts/hour with  $g_{a\gamma\gamma} = 10^{-10} \text{ GeV}^{-1}$  and  $A = 14 \text{ cm}^2$

# CAST: CERN Axion Solar Telescope

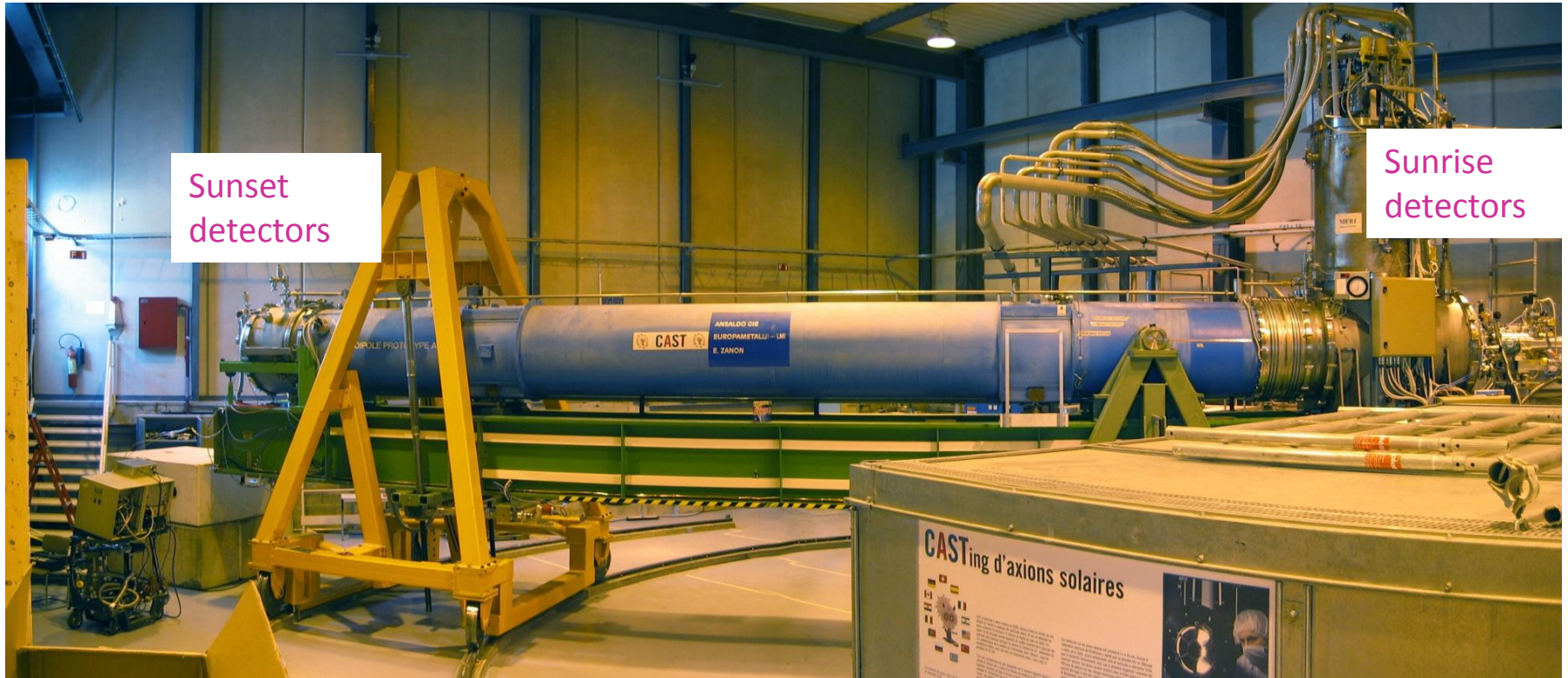

Sunset  
detectors

Sunrise  
detectors

LHC dipole :  $L = 9.3 \text{ m}$ ,  $B = 9 \text{ T}$

Rotating platform : vertical mouvement  $16^\circ$

horizontal mouvement  $100^\circ$

Solar « Tracking »  $\sim 3 \text{ h/day}$ , background data rest of the day

4 X-rays detectors

Signal: excess of X-rays  
while pointing the sun

# Originalities of CAST

- Use of X-ray telescope  $\rightarrow$  increase S/B noise  $\rightarrow$  sensitivity improved by a factor 150 by focusing a  $\varnothing 43$  mm x-ray beam to  $\varnothing 3$  mm

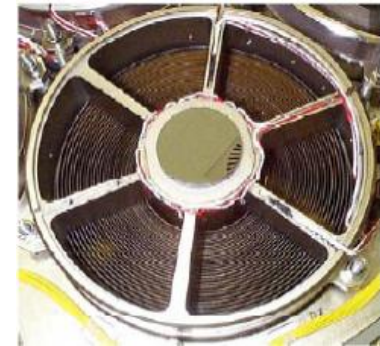
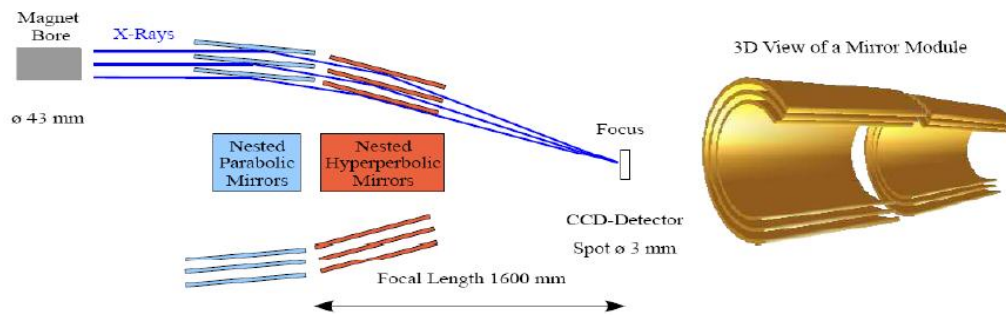

- Low background techniques  $\rightarrow$  shieldings, low radioactive materials, simulation and modeling of backgrounds....

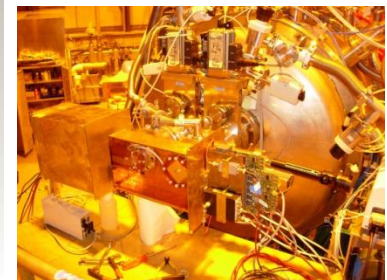
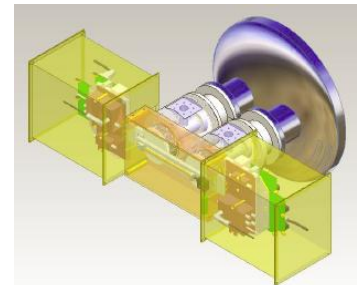
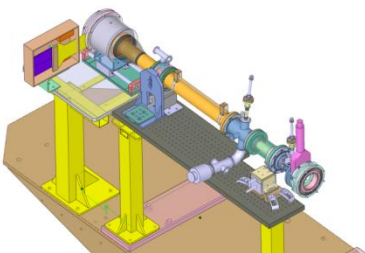

# Present detectors

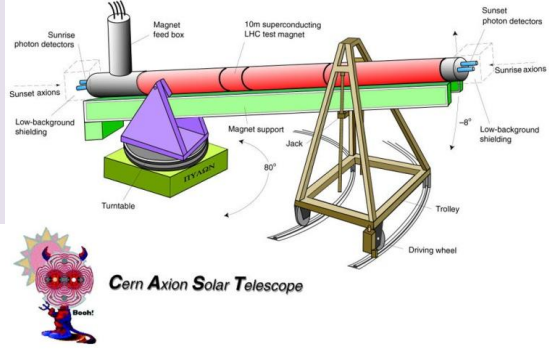

	Typical Rates
MM	2 counts/h (2-10 keV)
CCD+telescope	0.18 counts/h (1-7 keV)

**SUNRISE SIDE**  
Shielded Micromegas last generation-Microbulk type

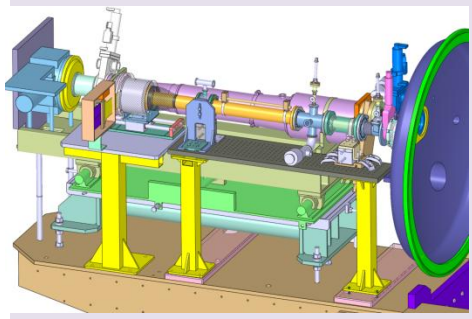

CCD +telescope

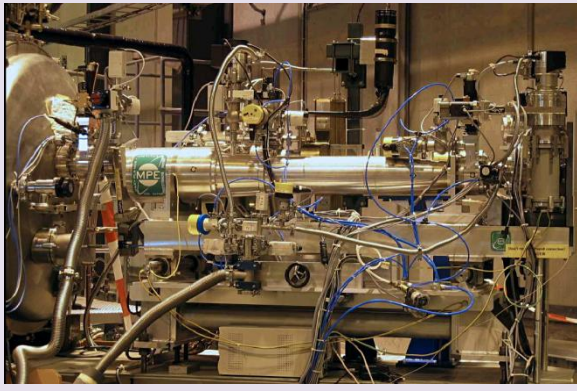

**SUNSET SIDE:** two shielded Micromegas last generation-Microbulk type

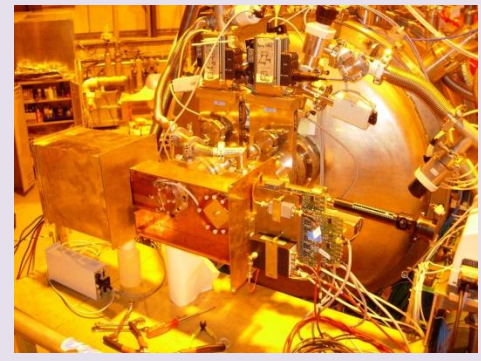
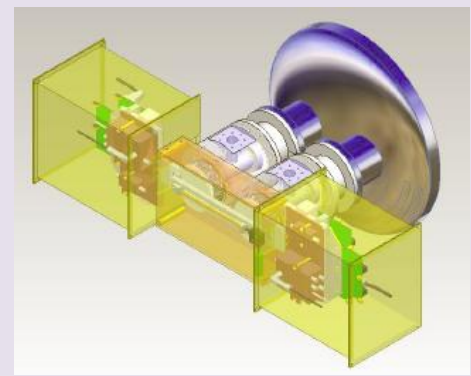

# CAST SENSITIVITY

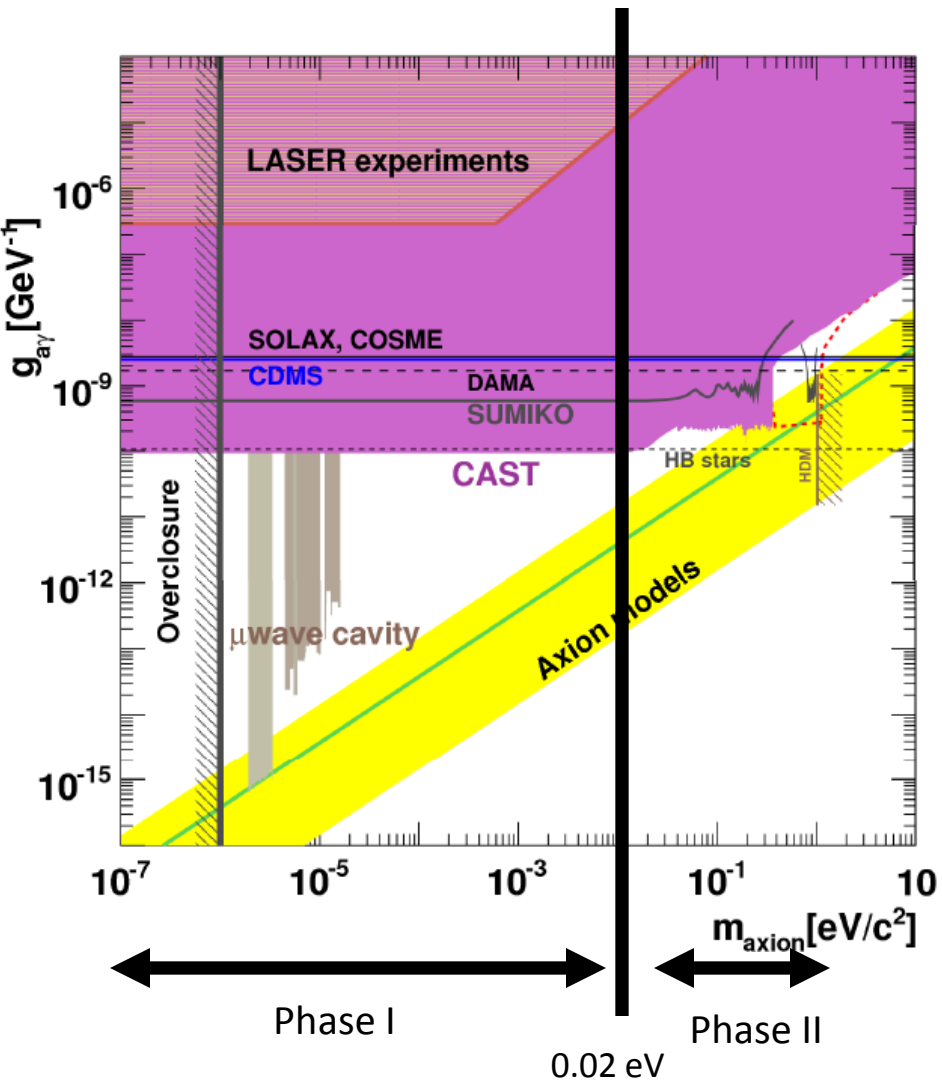

1) CAST Phase I: (vacuum operation)  
 completed (2003 - 2004)  
 $m_a < 0.02$  eV

2) CAST Phase II: (buffer gas operation)  
<sup>4</sup>He completed (2005 -2006)  
 $0.02$  eV  $< m_a < 0.39$  eV

<sup>3</sup>He run, commissioning in Nov 2007  
<sup>3</sup>He run, data taking started in Mar 2008  
 approved until Dec 2010  
 $0.39$  eV  $< m_a < 1.20$  eV

3) Low energy axions (2007 – 2010)  
 in parallel with the main program  
 ~ few eV range and 5 eV – 1 keV range



# Extending sensitivity with a buffer gas

In vacuum:

$$P_{a \rightarrow \gamma} = 1.74 \times 10^{-17} \left( \frac{B \cdot L}{9.0 \text{T} \cdot 9.26 \text{m}} \right)^2 \left( \frac{g_{a\gamma}}{10^{-10} \text{GeV}^{-1}} \right)^2 \cdot |M|^2$$

$$|\vec{q}| = \left| \frac{m_a^2}{2E_a} \right| \quad |M|^2 = \frac{2(1 - \cos(qL))}{(qL)^2} \quad qL \ll 1 \implies |M|^2 = 1$$

For  $m_a > 10^{-2} \text{ eV}/c^2$  coherence is lost

In a gas:

$$P_{a \rightarrow \gamma} = \left( \frac{B g_{a\gamma}}{2} \right)^2 \frac{1}{q^2 + \Gamma^2/4} [1 + e^{-\Gamma L} - 2e^{-\Gamma L/2} \cos(qL)]$$

$$|\vec{q}| = \left| \frac{m_a^2 - m_\gamma^2}{2E} \right|$$

Absorption coefficient :  $\Gamma$

Coherence condition :

$$qL < \pi$$

Filling the magnet with a buffer gas provides the photon a mass

$$m_{\gamma, \text{eff}} \approx \sqrt{0.02 \frac{P[\text{mbar}]}{T[\text{K}]}} [\text{eV}/c^2]$$

Coherence condition is recovered for a mass interval around  $m_\gamma$

$$qL < \pi \implies \sqrt{m_\gamma^2 - \frac{2\pi E_a}{L}} < m_a < \sqrt{m_\gamma^2 + \frac{2\pi E_a}{L}}$$

The masses can be adjusted changing the pressure of the gas

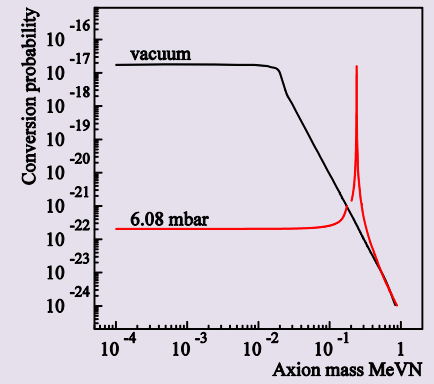

# Relevant CAST upgrades

## Installation of 3 last generation Micromegas detectors- Microbulk type with full shielding:

High radio-purity materials (Kapton, copper, plexiglass).  
Potential for ultra-low background rates.

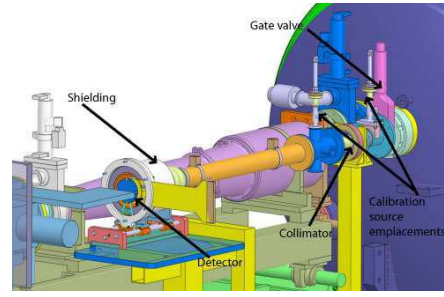
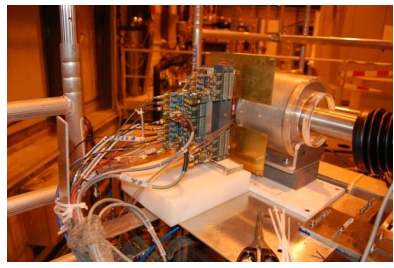
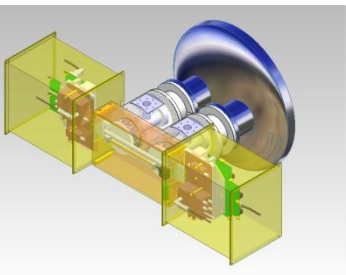
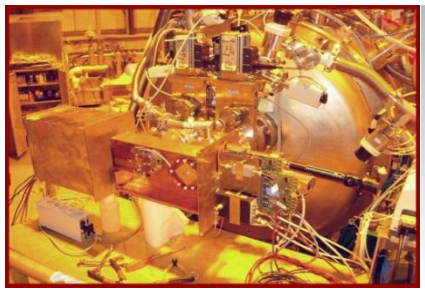

## New <sup>3</sup>He system:

Automated gas filling and recovery.



## A 5<sup>th</sup> line for visible photons connected to the sunrise MM line:

A 3.5 μm aluminized Mylar foil (transparent to X-rays) deflects visible photons on an angle 90°, towards the PMT/APD (2010)

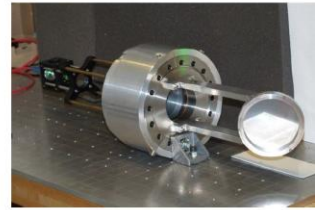
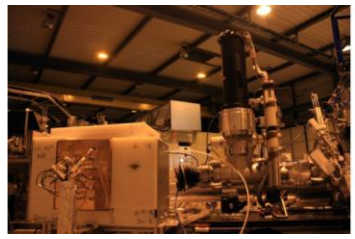

# CAST published results

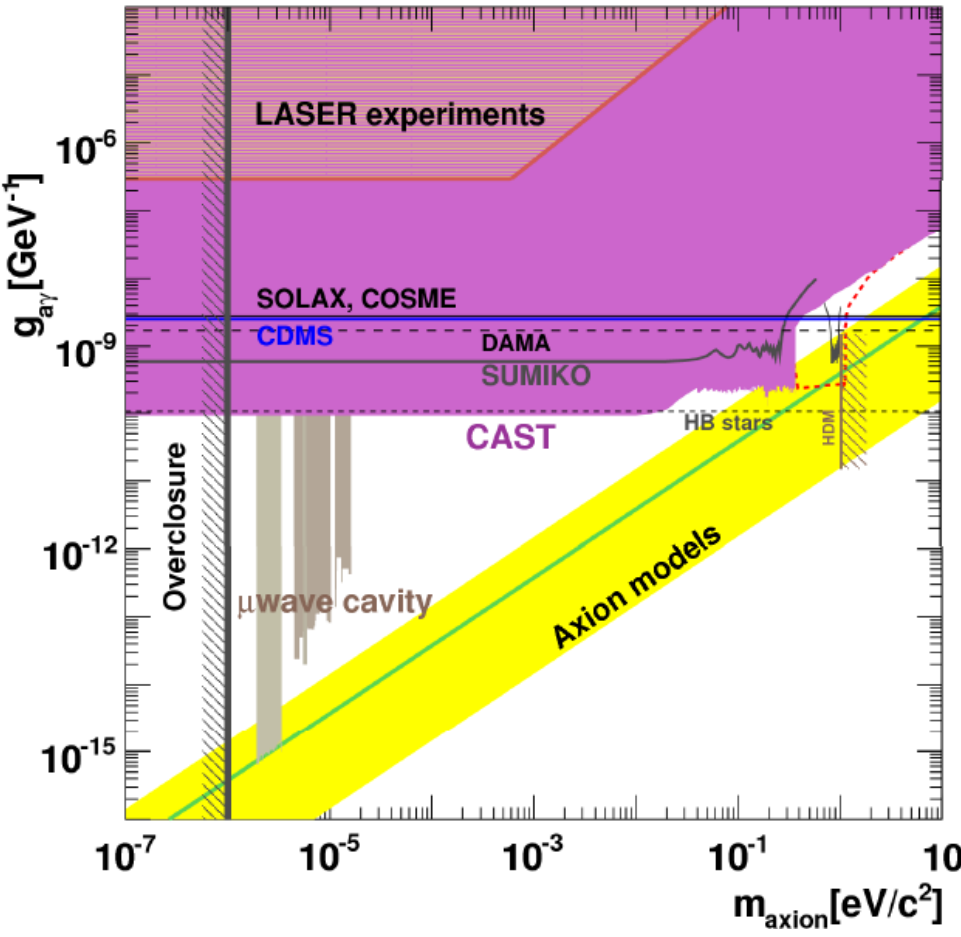

CAST search gives the most restrictive experimental limit in most of the favored (cosmology/astrophysics) parameter space

**For  $m_a < 0.02$  eV:**  
 $g_{a\gamma\gamma} < 0.88 \times 10^{-10} \text{ GeV}^{-1}$

JCAP04(2007)010, CAST Collaboration  
 PRL (2005) 94, 121301, CAST Collaboration

**For  $m_a < 0.39$  eV:**  
 $g_{a\gamma\gamma} < 2.2 \times 10^{-10} \text{ GeV}^{-1}$

JCAP 0902:008,2009, CAST Collaboration

**CAST byproducts:**

**High Energy Axions:** Data taking with a HE calorimeter  
 JCAP 1003:032,2010

**14.4 keV Axions:** TPC data (before 2006)  
 JCAP 0912:002,2009

**Low Energy (visible) Axions:** Data taking with a PMT/APD.  
 arXiv:0809.4581

# Analysis of the $^3\text{He}$ data

High precision filling and reproducibility is mandatory for each pressure setting.

Gas homogeneity is guaranteed by the surrounding superfluid  $^4\text{He}$  along the magnet region.

However at higher densities,  $^3\text{He}$  Phase data-taking period, window temperature cannot be kept as much stable. It can vary during tracking and may depend on the buffer gas density.  $\rightarrow$  SIMULATION EFFORTS + installation of temperature sensors along the magnet

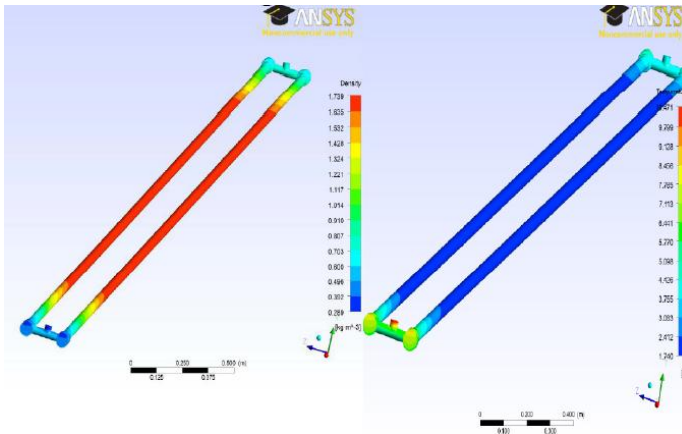

Temperature and density studies for several magnet angles.

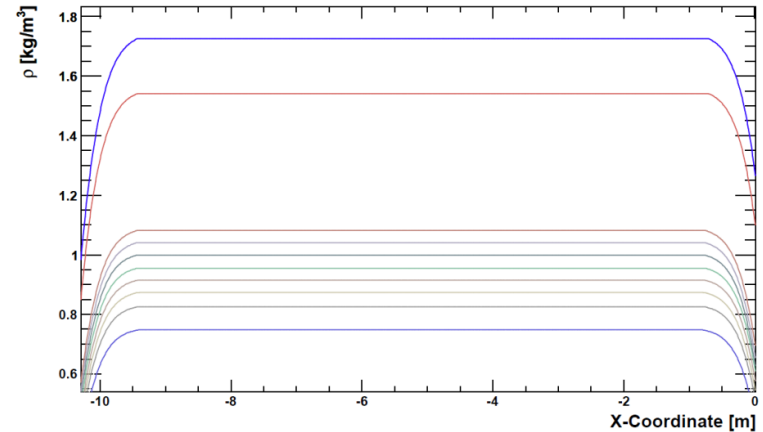

Magnet pipe density distribution at different pressure settings and boundary conditions.

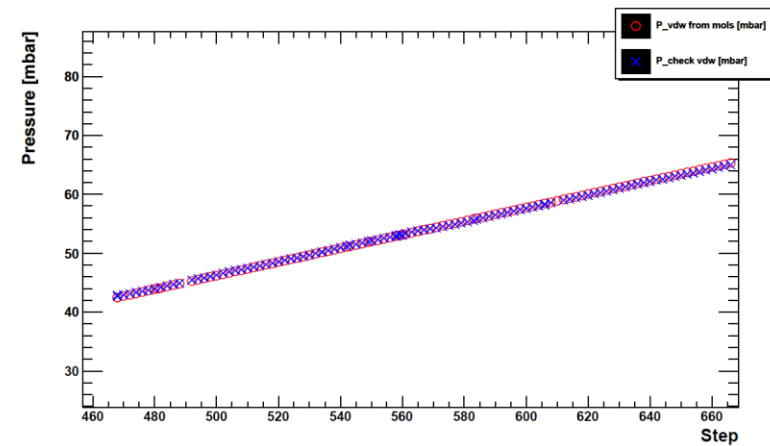

Agreement between simulated and measured pressure.

# A first preliminary exclusion plot with $^3\text{He}$ data

$$\text{Log}(L_{m_a}(g_{a\gamma})) = \underbrace{-g_{a\gamma}^4 \int_E \int_{t_k} \frac{d^2 n_\gamma}{dE \cdot dt_k} dE \cdot dt_k}_{\text{Zero counts detected contribution}} + \sum_{k_{n_j}=1} \underbrace{\text{Log} \left( b_{ik} + g_{a\gamma}^4 \int_{E_i}^{E_i+\Delta E} \frac{dn_\gamma^k}{dE} \right) dE}_{\text{One count detected contribution}}$$

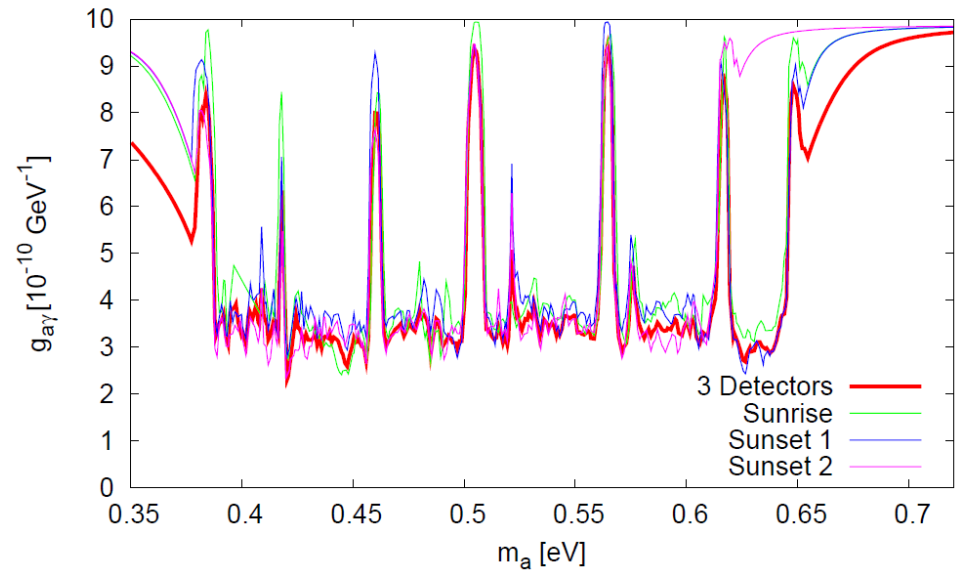
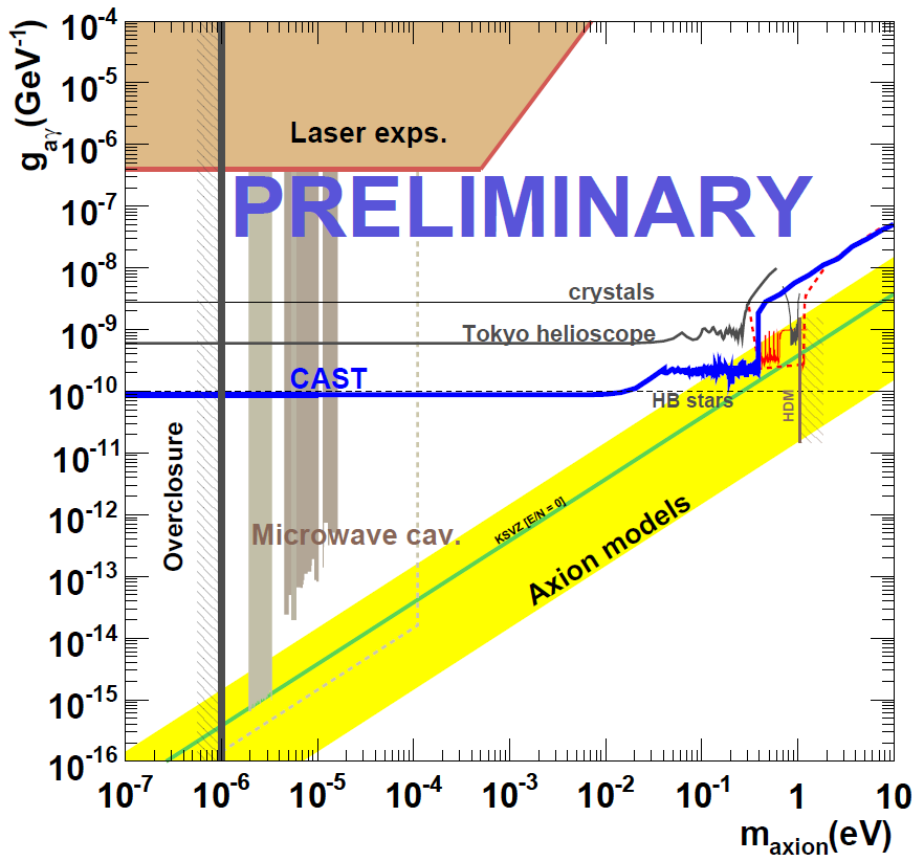

# Next generation of helioscopes

$$g_{\alpha\gamma\gamma} \propto \underbrace{(BL)^{1/2} \times A^{1/4}}_{\text{magnet}} \times \underbrace{b^{1/8}}_{\text{Detector}} \times \underbrace{t^{1/8}}_{\text{tracking system}}$$

## Magnet possible upgrades

Strong dependence with B,L but small improvement margins for next decade

- ➔ Concentrate effort on magnet bore's aperture
- ➔ Work with magnet expert's to design a dedicated magnet for a helioscope
- ✓ The constraints are different from accelerator magnets, i.e homogeneity is not as important as in accelerators
- ✓ An "ATLAS – like" configuration proposed by L. Walckiers is the most promising
  - Big aperture (~1 m) / multiple bores seem possible
  - Big magnetic field possible (new superconductive material)
  - Lighter construction than a dipole

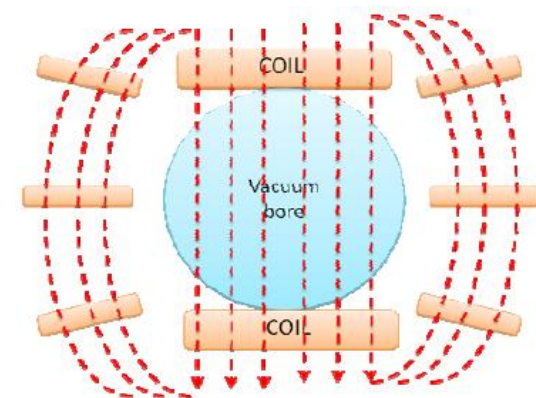
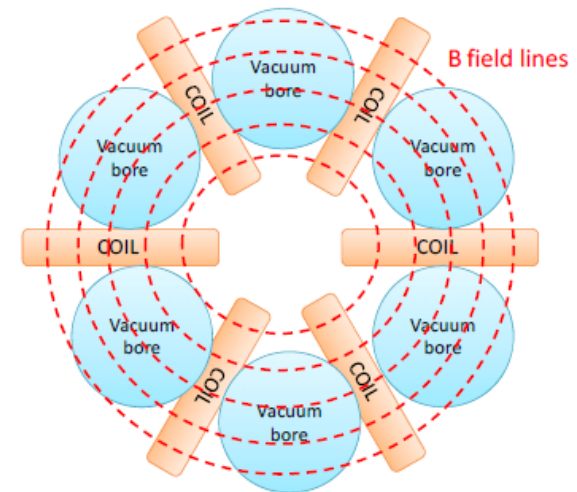

# Next generation of helioscopes

## Detector upgrades

- Ongoing simulations
- Ongoing background measurements in a controlled environment (underground laboratory Canfranc)
- Optimized detector design

## X-ray optics upgrades

- Cover big aperture
- High efficiency (>50%)

See T. Papaevangelou's talk at New opportunities in the Physics Landscape at CERN Workshop (May 2009) where different scenarios were presented

Can reach sensitivity of the order of  $10^{-11}$   $\text{GeV}^{-1}$  and probe a wide range of QCD favored model region

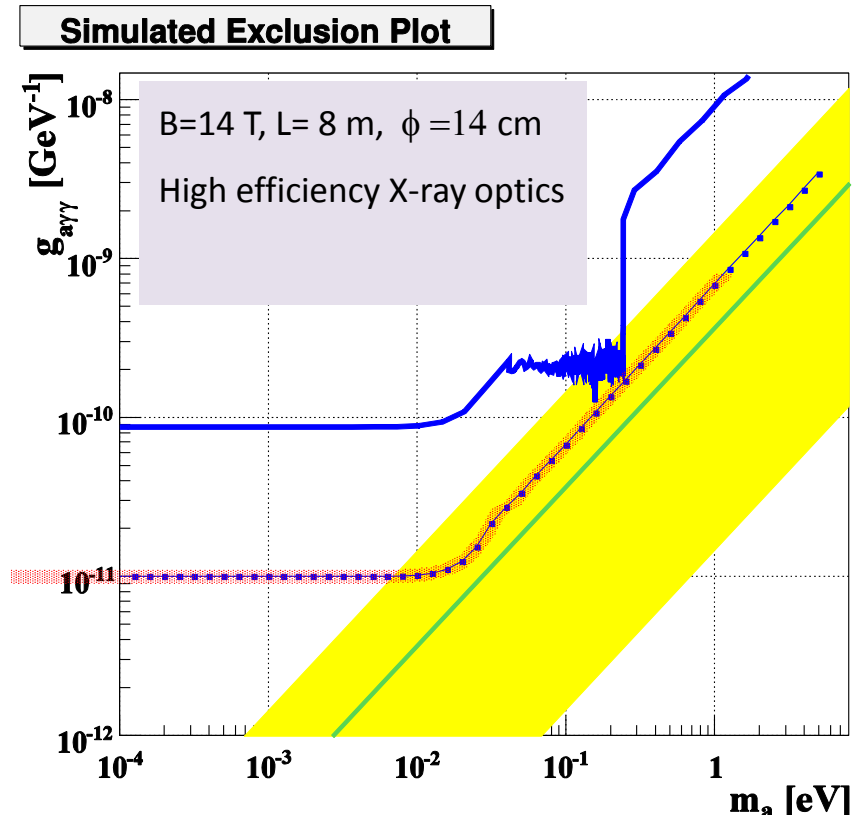

# Conclusions & perspectives

- During the 10 years of existence of CAST the exclusion limits up to now
  - Compatible with best astrophysical limits
  - Entering realistic QCD axion model band for the first time over a wide range of masses
- The hunt for the axion continues. We are exploring a very exciting region. Everyday place for discovery!
- Thinking of the next generation of Helioscopes which could be complementary with dark matter axion searches (ADMX) a big part of model region could be explored in the next decade
  - Dedicated magnet development
  - R & D on detectors and X-ray optics

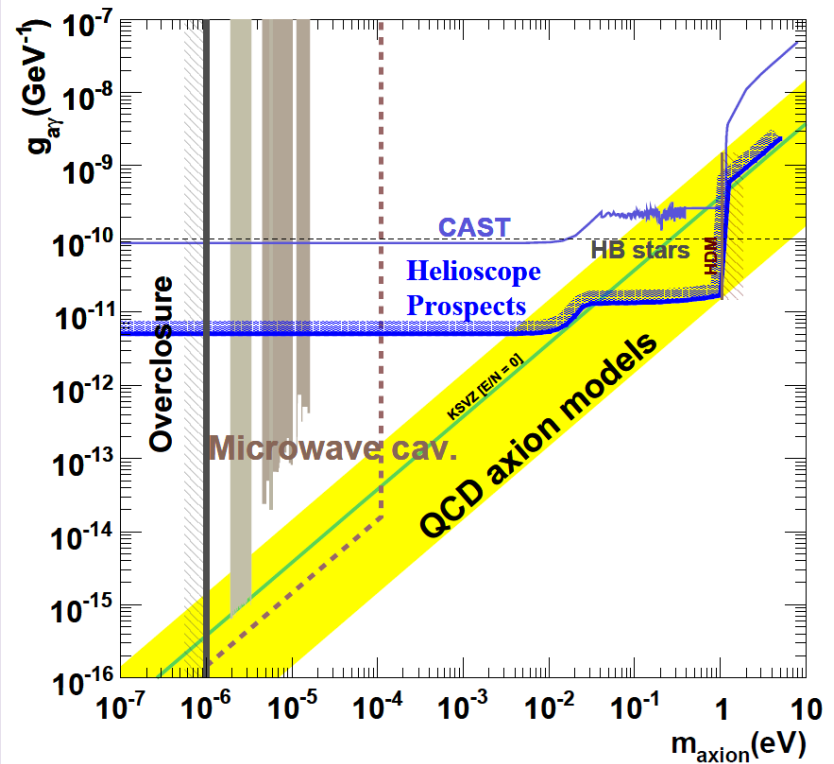



**BACK UP**

# Detectors before 2006

**SUNRISE SIDE:**  
unshielded Micromegas

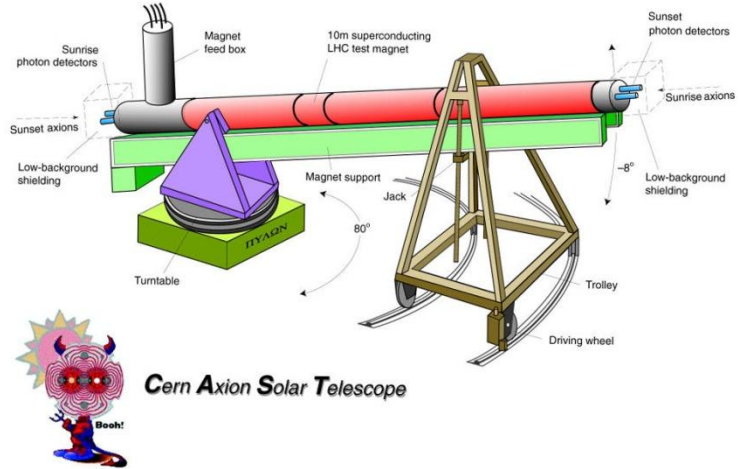
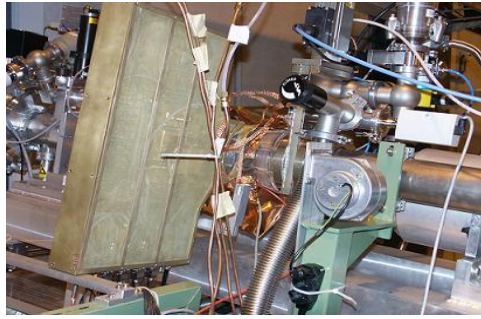

**CCD +telescope** (prototype for the ABRIXAS Space mission):  
enhanced sensitivity by improving S/B

**SUNSET SIDE: shielded TPC**  
(looking at two magnet bores)

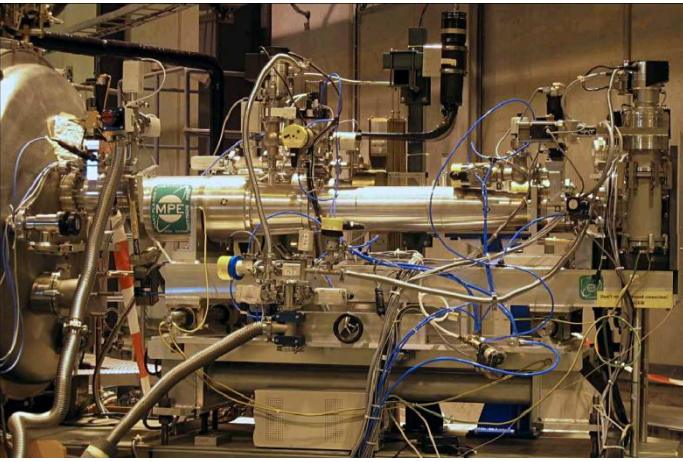

	Typical Rates
TPC	85 counts/h (2-12 keV)
MM	25 counts/h (2-10 keV)
CCD	0.18 counts/h (1-7 keV)

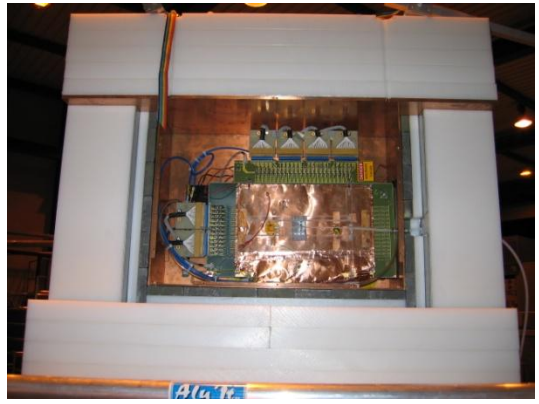

$\Phi$  43 mm (LHC magnet aperture)  
=>  $\Phi$  3 mm (spot of the sun)

# Tracking system precision

Several yearly checks cross-check that the magnet is following the Sun with the required precision

## GRID Measurements

- Horizontal and Vertical encoders define the magnet orientation
- Correlation between H/V encoders has been established for a number of points (GRID points)
- Periodically checked with geometer measurements

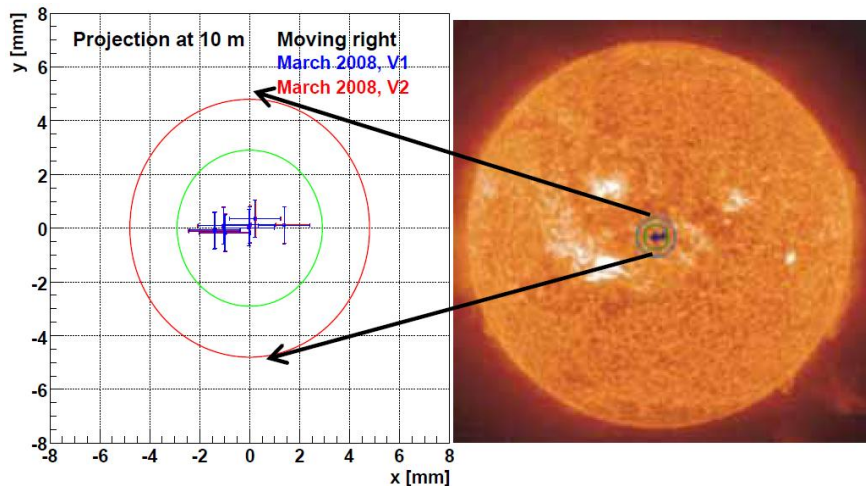

## Sun Filming

- Twice a year (March – September) Direct optical check. Corrected for optical refraction
- Verify that the dynamic Magnet Pointing precision ( $\sim 1$  arcmin) is with our acceptance

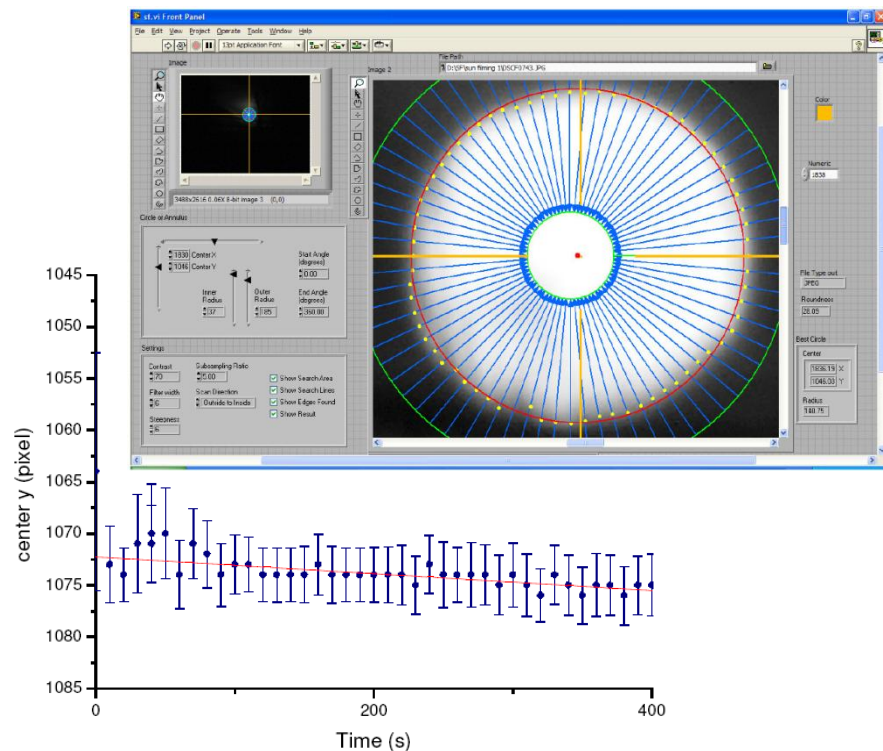

# New Micromegas detectors and potential for ultra low background

- Very low background: Without loss of efficiency
- Not really understood yet

Nominal background : 1.6 counts/hour  
Ultra-low background : 0.1 counts/hour

- Ultra background reduction could be related with clean atmosphere (Nitrogen) surrounding the detector

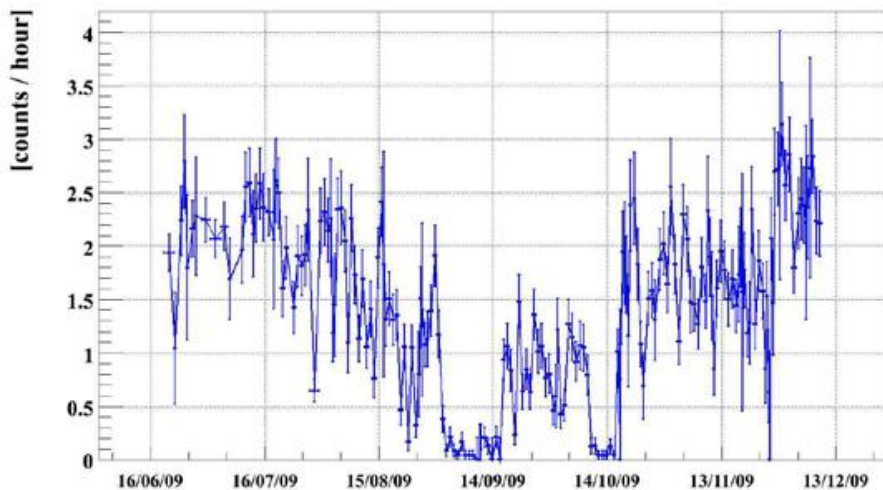

Studies going on to reproduce conditions of stable ultra-low background detectors.

**Extremely detailed Geant4 Simulations (A. Tomas)**

+

**Stable Underground measurements**

2010 JINST 5 P01009

2010 JINST 5 P02001

