

Future Upgrade Scenarios for the Injector Complex
Upgrade possibilities in the SPS

E. Shaposhnikova for SPSU SG

LHC Performance Workshop – Chamonix,

28.01.2010

Outline

- Present status
- SPS limitations
- Possible actions
- Summary

Acknowledgments:

SPS Upgrade Study Group

BE/RF: T. Bohl, E. Ciapala, W. Hofle, T. Linnecar, E. Montesinos,
J. Tuckmantel

SPS Upgrade Study Group

Study Group (BE, TE), since March 2007:

G. Arduini, J. Bauche, F. Caspers, S. Calatroni, P. Chiggiato, K. Cornelis, E. Mahner, E. Metral, G. Rumolo, B. Salvant, E. Shaposhnikova, M. Taborelli, C. Yin Vallgren, F. Zimmermann

+ contributions from different groups (ABP, ABT, BI, MSC, OP, RF, VSC...)

+ impedance team (chaired by E. Metral)

Main tasks:

- Identify limitations for intensity increase above nominal
- Study and propose solutions
- Design report with cost and planning for proposed actions

Meetings (~1/month), talks, minutes: <http://cern.ch/spsu/>

SPS: present achievements

Parameters	SPS record at 450 GeV/c		LHC request 25 ns	
	25 ns	FT	nominal	ultimate
bunch intensity/ 10^{11}	1.2	0.13	1.2	1.8
number of bunches in SPS	288	4200	288	288
total intensity/ 10^{13}	3.5	5.3	3.5	5.2
long. emittance [eVs]	0.7	0.8	<1.0	<1.0
norm. H/V emitt. [μm]	3.6	8/5	3.5	3.5

→ SPS upgrade is necessary for intensity above nominal LHC

SPS beams with PS2

Parameters	With PS2 at 50 (25) GeV/c			SPS record at 450 GeV/c	
	LHC	LHC	FT	LHC	FT
bunch spacing	25 ns	50 ns	25 ns	25 ns	5 ns
bunch intensity /10 ¹¹	4.0	5.5	1.2	1.2	0.13
number of bunches	2x168	2x84	815	288	4200
total intensity /10 ¹³	13.4	4.6	10.0	3.5	5.3
long. emittance [eVs]	0.6	0.7	0.4	0.6	0.8
norm. H/V emitt. [μm]	3.0	3.0	9/6	3.6	8/6

M. Benedikt et al., PS2 WG

SPS upgrade for

I. Ultimate LHC intensity - 26 GeV/c injection

- 1.7×10^{11} /bunch, 25 ns spacing, 288 bunches

II. PS2 max. intensity - 50 GeV/c injection

- 4×10^{11} /bunch, 25 ns spacing, 336 bunches, total 1.3×10^{14}
- 5.5×10^{11} / bunch, 50 ns spacing, 168 bunches

Intensity limitations identified

- **Single bunch effects:**
 - TMCI (transverse mode coupling instability)
 - space charge
- **Multi-bunch effects:**
 - beam loss
 - e-cloud
 - longitudinal coupled bunch instabilities
 - beam loading in the 200 MHz and 800 MHz RF systems
 - heating of machine elements (MKE, MKDV kickers, ...)
 - vacuum (beam dump and MKDV outgassing), septum sparking
(**ZS** was a main limitation in 2008 and 2009 → 3 nominal LHC batches)

Single bunch effects

Space charge

- Limit for space charge tune spread (ppbar): 0.07
- 26 GeV/c
nominal intensity: 0.05
ultimate intensity: 0.07
- 50 GeV/c
 5.5×10^{11} (max PS2): 0.06

Microwave instability

- After impedance reduction (2001) is not observed even for small long. emittances

TMCI

- Threshold intensity scales (matched voltage) $\sim \varepsilon_L \eta$
- Threshold (impedance model fit to measurements) $\sim 1.4 \times 10^{11}$
Cures: higher chromaticity, ε_L , impedance reduction... but 40-50% of transverse SPS impedance is still **unknown** → ongoing work (impedance team)
- 50 GeV/c – factor 2.5 increase in the TMCI threshold $\sim \eta$
→ 3.5×10^{11}

SPS limitations: beam loss

- Significant particle loss for **nominal LHC beam** (flat bottom + capture): from **20%** at the beginning of year to **10%** at the end
- Relative losses increase with beam intensity, strong dependence on batch intensity, less on total (number of batches)
- Much smaller ($\sim 5\%$) relative losses for 75 ns and 50 ns bunch spacing for the same bunch intensity \rightarrow not single bunch effect; loss decrease during scrubbing run; different lifetime in the head and tail of batch \rightarrow **e-cloud?**

To have the same absolute losses relative losses should be reduced for higher intensities

- \rightarrow the origin of beam loss
- \rightarrow e-cloud mitigation
- \rightarrow beam collimation (?)

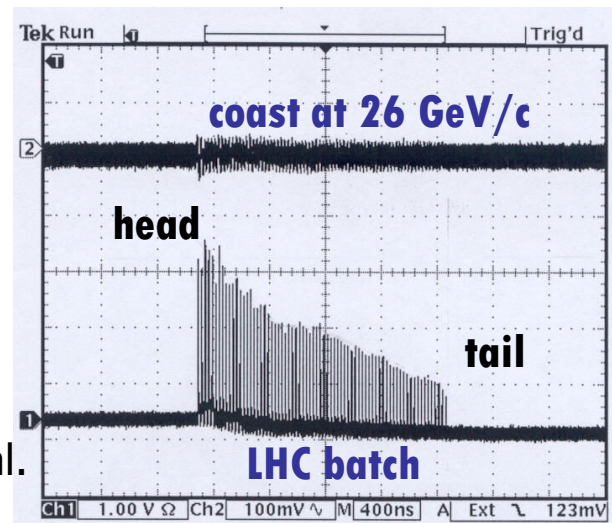

T. Bohl et al.

SPS limitations: e-cloud

- Pressure rise, transverse emittance blow-up, beam losses, instabilities
- Cures: scrubbing run, high V chromaticity, feedback (H)
- Beam energy dependence:
 - H-plane: e-cloud instability growth time \sim beam energy
 - V-plane: instability threshold is decreasing with energy
(for constant norm. emittances, bunch length and matched voltage)

Studies of the scaling law in the SPSU SG:

- HEADTAIL simulations
- measurements during ramp with reduced chromaticity and damper gain
- special cycle with flat portion at 55 GeV/c \rightarrow dependence on transverse size confirmed (G. Rumolo et al. PRL, 100, 2008)

e-cloud mitigation

SPS requirements:

- applicable to the existing stainless steel vacuum chamber inside 6 m long magnets without dismantling
- no aperture reduction (thickness < 0.5 mm)
- no bake-out above 120 deg
- no re-activation
- no ageing with venting
- low impedance
- long-term stability
- good vacuum properties, no (small) outgassing

Possible e-cloud mitigation

- **Coatings**

- low SEY amorphous carbon (a-C), SEY < 1 (1.3 is critical for SPS), stainless steel (StSt) – 2.5 (1.5 after scrubbing)
 - rough surfaces

- **Clearing electrodes all along the beam pipe**

- fixing (needs 600-800 deg)
- impedance

- **Grooves** (M. Pivi et al.)

- manufacture, test with beam, aperture, impedance

- **Active damping system in V plane** (W. Hofle et al., LARP)

- feasibility (instability growth rate, frequency)
- large bandwidth
- incoherent effects

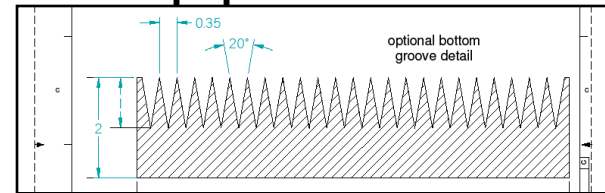

e-cloud experimental set-up in 2008-2010

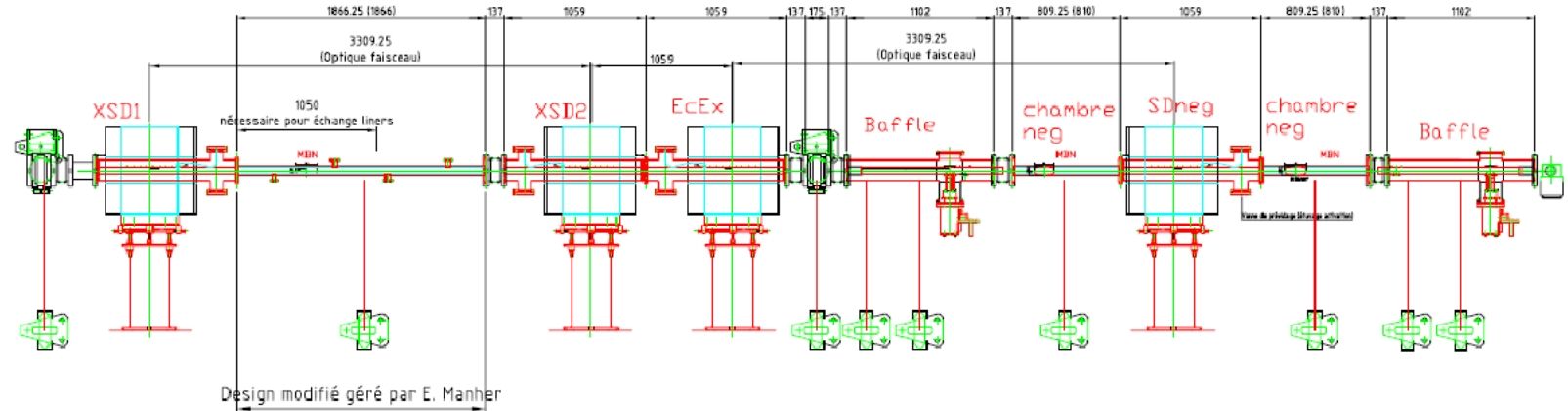

- 4 strip-line monitors XSD:
 - (1)-(2) St-St for reference and **pressure measurement (new)**
 - (3) - **old a-C coating**
 - (4) – a-CZr (rough)
 - Clearing (enamel) electrodes with button PUs (2008)
 - C - magnet with exchangeable samples (St-St in 2008, a-C in 2009)
- Plus e-cloud set-ups in **PS** and **Linac3** (a-C, clearing electrodes)

Possible vacuum chamber modification

- 2009:
 - 3 MBB spare magnets coated with a-C (60 mm top& bottom)
 - installed in the SPS (LSS5) with microwave and vacuum diagnostics
 - MDs with LHC beam
- 2010:
 - 1 MBB is out of ring for inspection
 - design of new coating system
 - modified microwave and vacuum diagnostics for 2 coated magnets

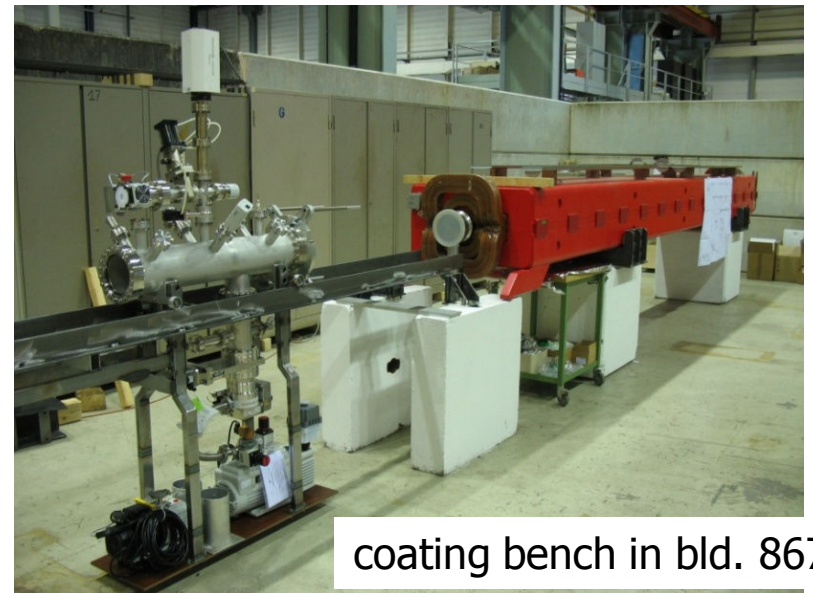

Results for a-C coating

Liners:

- 300 times smaller e-signal in a-C than in StSt
- conditioning (scrubbing) even for small SEY
- no ageing for a-C liners exposed to the beam (4 times less signal in old a-C)

Magnets:

- absence of e-cloud confirmed by microwave transmission measurements (last MD in 2009),
- but no significant reduction in pressure rise

TiN coating was successfully used in PEP-II, but doesn't work so far in SNS ring

Stainless steel

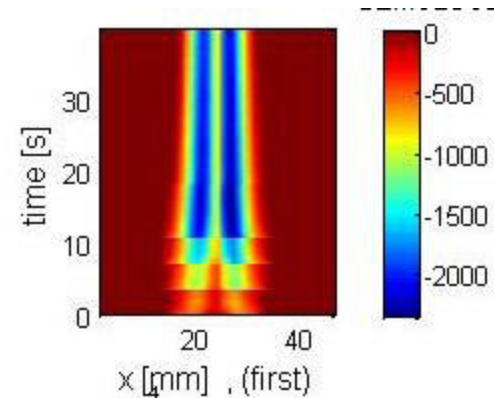

a-Carbon C-8

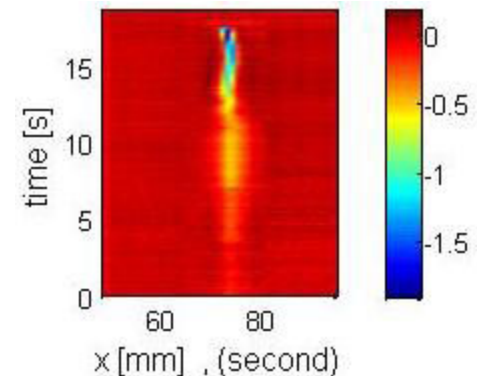

M. Taborelli et al.

a-C coating: open questions

- Long term behavior – ageing with venting and scrubbing
- What should be coated (dipoles, quadrupoles, pumping port shields +)?

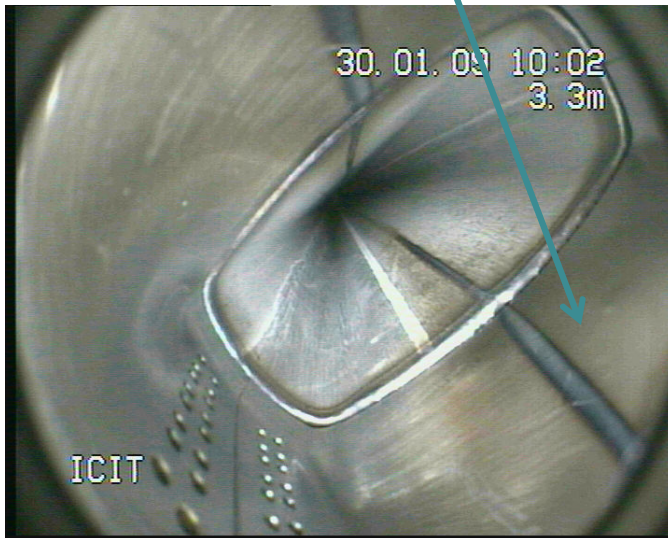

- Coating quality control
- Pressure (outgassing)

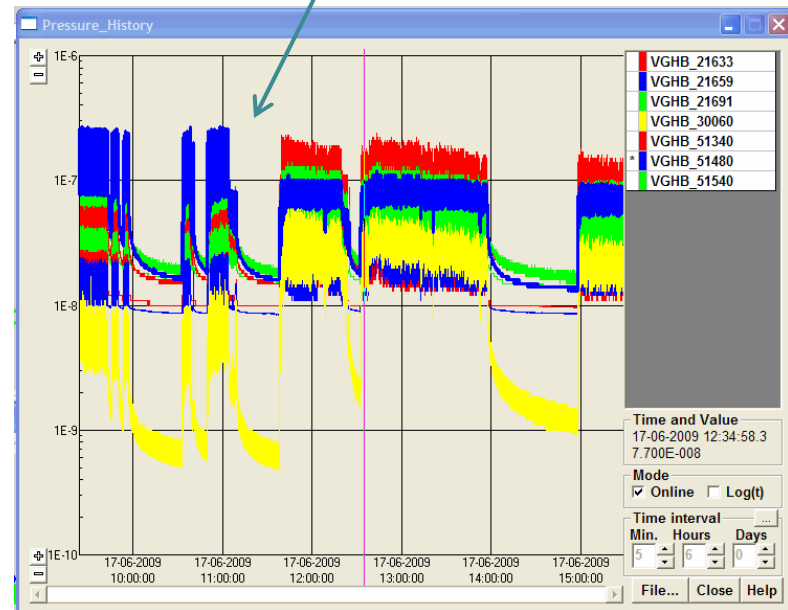

AEC'09: anti e-cloud coatings (that do not require activation) workshop CERN 12-13.10.2009 (with ACCNET)

40 participants, 13 external talks

CERN talks:

- 1 SPS upgrade plan & coating requirements – [E. Shaposhnikova](#)
- 2 What should be coated – [G. Rumolo](#)
- 3 Characterization of amorphous carbon coatings – [M. Taborelli](#)
- 4 Results on amorphous carbon coatings in e-cloud monitors of SPS – [C. Yin Vallgren](#)
- 5 Results and plans of CESR-TA experiments on low SEY coatings – [S. Calatroni](#)
- 6 Diagnostic of coating results – microwave measurements – [S. Federmann](#)
- 7 Diagnostics of coating results – pressure measurements – [M. Taborelli](#)
- 8 Impedance of coating – [D. Seebacher](#)
- 9 Amorphous carbon coating of SPS dipoles – [P. Pinto Costa](#)
- 10 Possible logistics of coating of SPS – [J. Bauche](#)
- 11 Clearing electrodes: the PS experience – [E. Mahner](#)

Possible vacuum chamber modification



S. Sgobba

Implementation in the SPS

- 750 vacuum chambers inside dipoles can be treated in **3-4 shutdowns**
- **Experience** due to installation of RF shields (1999-2001) and refurbishing of the cooling circuits of dipoles (2007-2009)
- **Infrastructure** partially exists (ECX5 cavern - $\varnothing 20$ m)
- **Vacuum system** (for coated chamber)
 - minimize air exposure during shutdowns and interventions

SPS limitations: impedance (1/2)

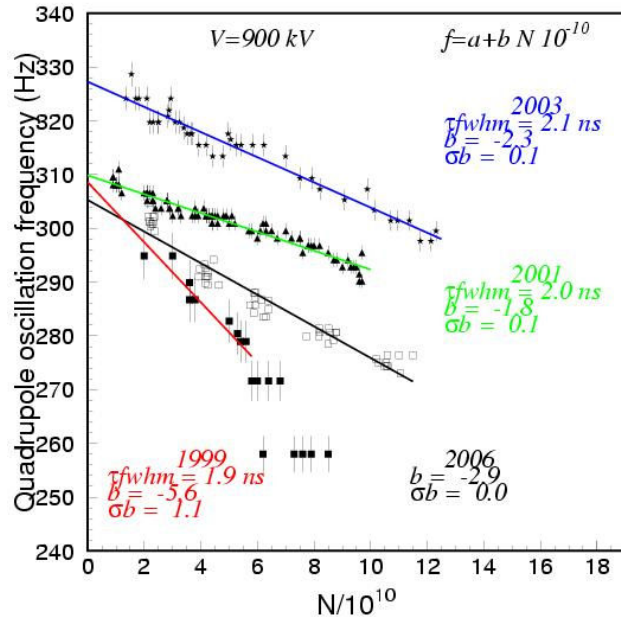

- 1999-2001: SPS impedance reduction in preparation for nominal LHC beam
- 2003-2006: impedance increase due to re-installation of 8 MKE (extraction kickers for LHC) – main contribution to longitudinal broad-band impedance budget (beam measurements and simulations)
- 2007-2010: small reduction (MKE) - not measurable yet

Quadrupole oscillation frequency as a function of bunch intensity: slope $\sim \text{Im } Z_{\text{eff}}$

SPS limitations: impedance (2/2)

- Search for **unknown** impedances:
 - transverse (broad-band) : only 60% known → **TMCI**
 - longitudinal (narrow-band - HOMs) → **coupled-bunch instability**→ SPS impedance budget from all elements (impedance team)
- **Known** high impedance elements:
 - **MKE** (M. Barnes): serigraphy (optimised?) – 3 done, 5 more in 3 years. Transverse impedance issue. New design?
 - **MKDV, MKDH**: 30 years old, no transition pieces between magnet and tank → heating, outgassing with 50 ns (MKDV1) and 75 ns (MKDV2) spaced beams. Spare MKDV1 with trans. pieces is now in the ring - OK
 - **800 MHz TW cavities**: active damping → RF feedback and feedforward (2009-2010), installation of probes in each cell (37/cavity)

SPS limitations: coupled-bunch instability

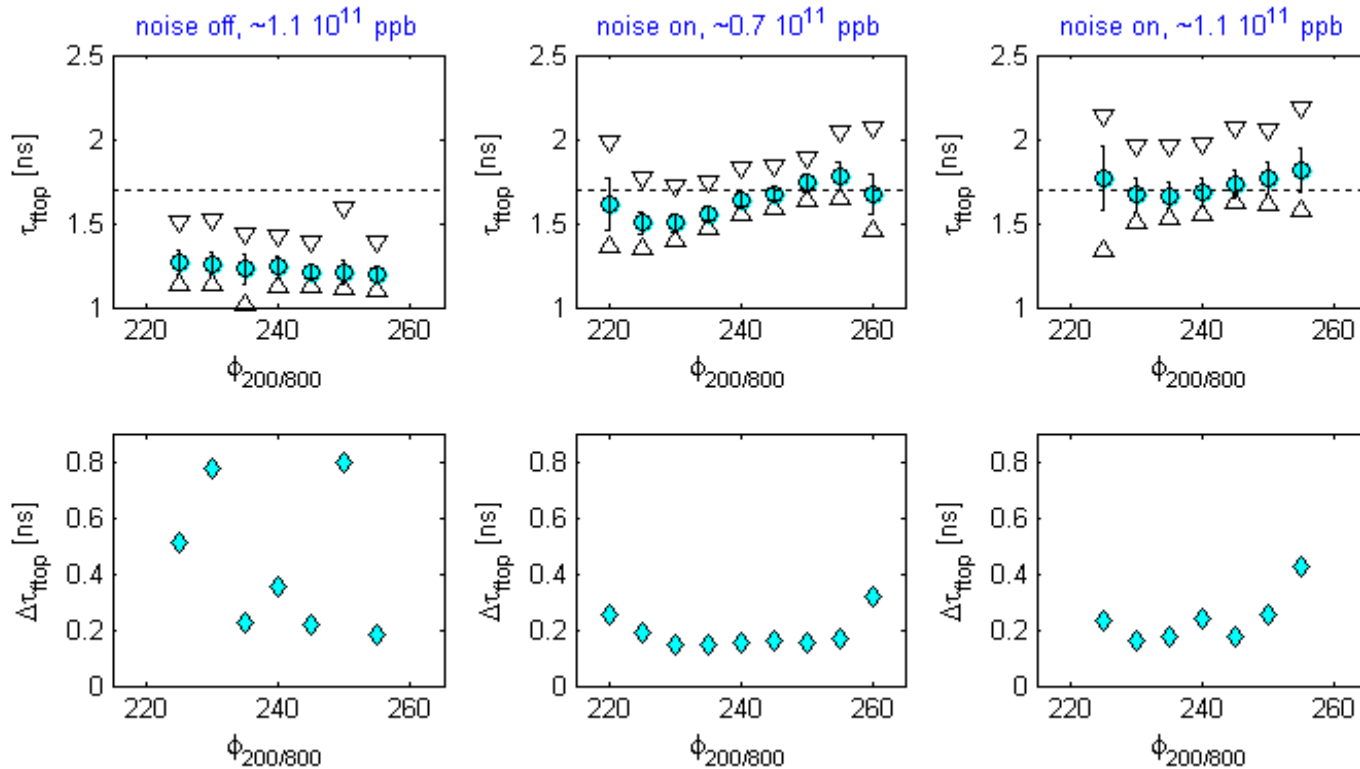

Bunch length
(av., max-min)
at 450 GeV/c

Beam stability
from $\Delta\tau$

G. Papotti et al.

Threshold $\sim 1/5$ nominal LHC bunch intensity \rightarrow FB, FF, dampers, 800 MHz RF
(in bunch-short. mode) + **controlled emittance blow-up: 0.42 \rightarrow 0.65 eVs**
 \rightarrow larger emittance needed for higher intensities – more RF!

200 MHz RF system in the SPS

- 4 Travelling Wave cavities:
 - 2 of 5 sections
 - 2 of 4 sections
 - 11 cells/section
 - 18 sections + 2 spares
- Total voltage: 8.0 MV
- Power/cavity (E. Montesinos):
 - 700 kW for full ring (CNGS)
 - 1(1.4) MW for half ring (LHC) - possible in pulsed mode (not tested yet)
 - limited by power amplifier, couplers and feeder lines

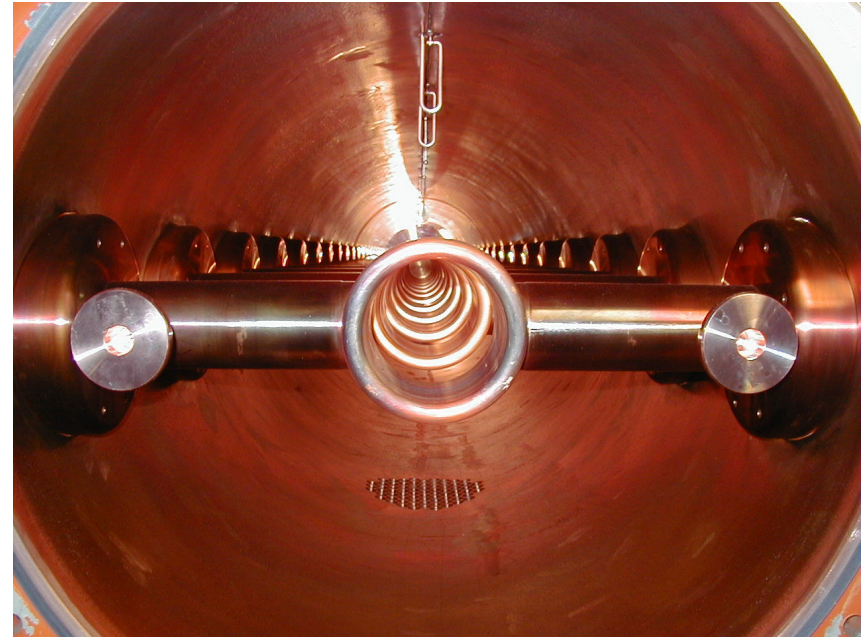

200 MHz RF system in the SPS

- Power (1 MW) and voltage (7.5 MV) limitations are still OK for acceleration of the ultimate LHC beam
- But if larger emittances ($\epsilon \sim \sqrt{N}$) are required for beam stability in the SPS or in LHC **beam transfer to the LHC 400 MHz RF system becomes critical:**
Since $\tau \sim (\epsilon/V^{1/2})^{1/2} \rightarrow$ for $\tau = \text{const}$
 $V = V_1 N_{\text{ult}}/N_{\text{nom}} = 1.48 V_1 = 10.3 \text{ MV}$
- Two possible solutions are:
 - to install the 200 MHz RF system in the LHC (E. Ciapala talk)
 - to rearrange the SPS 200 MHz RF

Power/cavity (LHC cycle) for different intensities

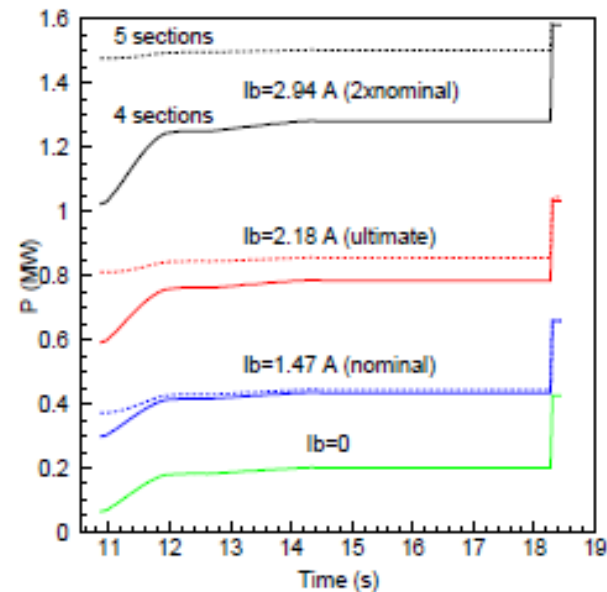

Voltage program:
flat top - 7.5 MV
acceleration – max 4.5 MV

200 MHz TW RF system: voltage/cavity

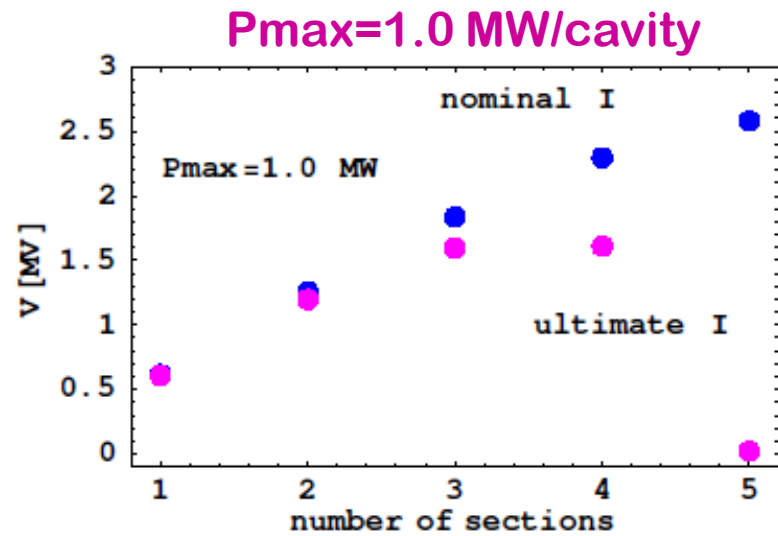
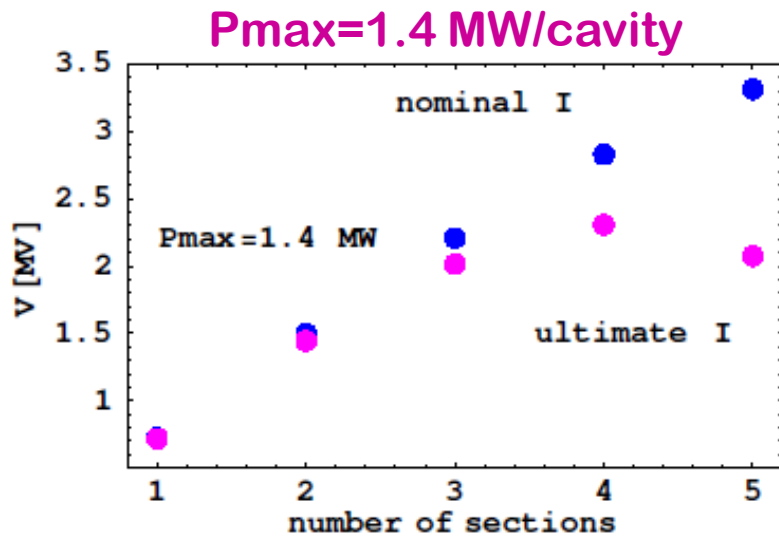

- 5-section cavities become less efficient at ultimate LHC current for power limit of 1.4 MW/cavity (T. Bohl, Chamonix 2000) and "useless" for 1 MW/cavity
- More voltage can be obtained by rearranging existing 4 cavities into 5 ($3 \times 4 + 2 \times 3 = 18$) or 6 ($2 \times 4 + 4 \times 3$) cavities
- Total power increase by 25% or 50% (5 or 6 cavities)

SPS RF system modification: impedance reduction

Total beam (peak) impedance of the 200 MHz TW RF system

$$Z = R/8 \sum L_n^2 = RL^2/8 \sum (n-1/11)^2$$

$$R = 27.1 \text{ k}\Omega/\text{m}^2,$$

n - number of sections per cavity

$$L_n = L(n-1/11), L = 11 \times 0.374 \text{ m}, RL^2/8 = 57.3 \text{ k}\Omega$$

4 cav. 2x5 & 2x4: Z = 4.5 M Ω - now

5 cav. 2x3 & 3x4: Z = 3.6 M Ω - 20% less

6 cav. 4x3 & 2x4: Z = 3.7 M Ω - 18% less

→ We have two more cavities in the SPS and reduce impedance!
(To compare with installation of the 200 MHz in LHC)

Total 200 MHz voltage on SPS flat top

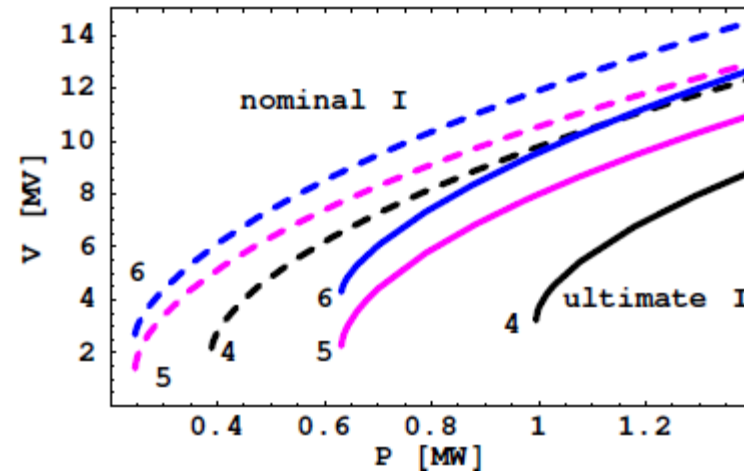
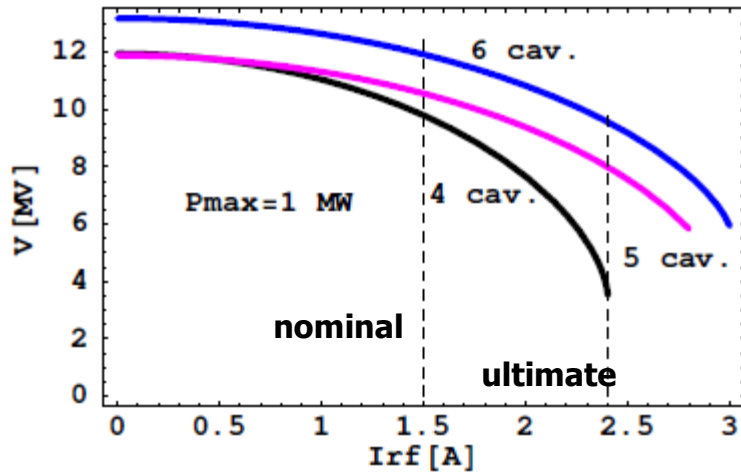

- Existing configuration will have problems at ultimate LHC current even at 1 MW
- The same voltage for ultimate current as for nominal could be obtained with 6 cavities and power of 1 MW

FT/CNGS acceleration cycle

Limitation for voltage required for acceleration for $P_{\max}=0.7$ MW

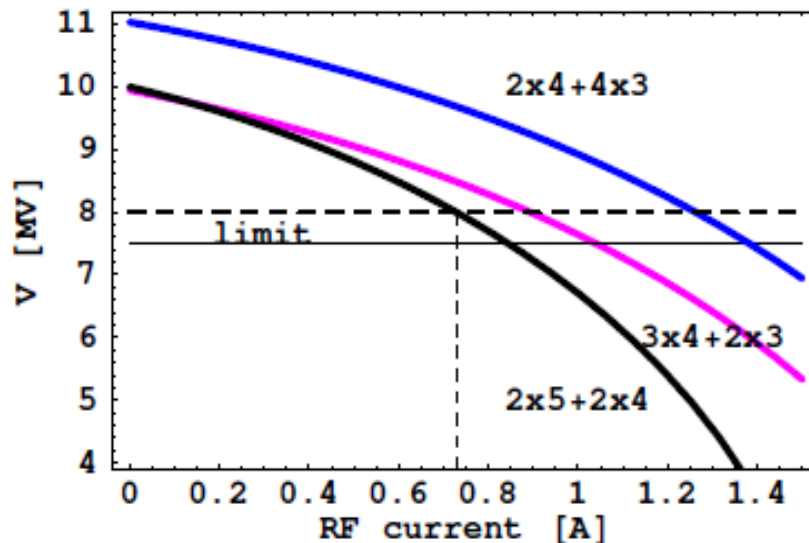

4200 bunches
spaced by 5 ns

0.73 A - RF current for
 $N = 4.8 \cdot 10^{13}$ (nominal
CNGS)

- Presently both voltage and power are at the limit: 7.5 MV used after transition crossing (uncontrolled emittance blow-up)
- Significant improvement for CNGS and fast LHC cycle with 6 cavities

200 MHz TW RF system upgrade - summary

- **How many:** significant gain in voltage even with 5 cavities, restored performance for LHC ultimate beam and improved for CNGS with 6 cavities
- **Where:** 1 or 2 cavities in LSS5 in addition to 4 shorter cavities in LSS3 (now) – civil engineering, cavity and beam control
- **When:** start project now to be ready for 2015 (Linac4)
- For maximum PS2 intensities (5.2 A) – more short cavities and power, 2 power plants (2 feeder lines) per cavity, ...

FT/CNGS beam in SPS with PS2

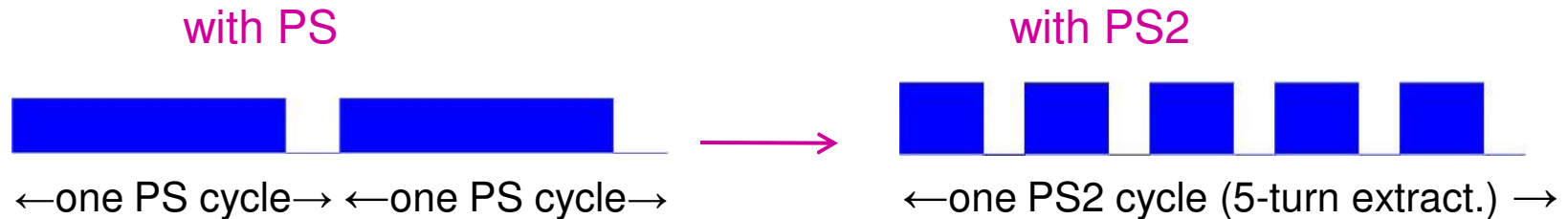

- SPS filling factor 0.91
- two gaps of 1.05 μs each
- transition crossing
- no bunch-to bucket transfer

- no transition crossing
- bunch-to-bucket transfer
- no flat bottom
- SPS/PS2 geometrical gap: 0.6 μs , min PS2 kicker gap: 0.3 μs → max SPS gap of 0.9 μs (1.05 μs now) for the same SPS filling factor as now (0.91)
- CNGS beam: MKE rise time and kick length (max 12 μs now) → for fast extraction of full ring $5 \times 1.05 + 0.6 = 5.85 \mu\text{s}$ total gap! → 0.9 μs kicker rise time and 22 μs kick length (B. Goddard)

Internal beam dump (LSS1)

Limitations

- TIDGV: energy range 105-450 GeV, TIDH for beams < 37 GeV
→ no dumping possible in range (37-105) GeV
- TIDVG (M. Genbrugge, Y. Kadi, A. Stadler):
 - outgassing during dumps, pressure rise → interlock (MKP)
 - limits for dumping current and future beams (Antico $T < 450^\circ$)
 - absorbs only 155 GeV/p (at 450 GeV)→ New design for higher intensities
- MKDV (M. Barnes, B. Goddard):
 - injection at 50 GeV → larger dynamic range of the switch
 - kicker rise time $> 1 \mu\text{s}$ → beam gaps with PS2 (FT beam)
 - impedance (heating, outgassing))→ Development of fast semiconductor switch

Hardware modifications

For ultimate LHC intensity

- ZS (electrostatic septa) – show-stopper for nominal LHC beam in 2008-2009
- Impedance reduction – MKE, MKDV, MKDH + more (as identified)
- SPS magnet coating after successful tests (in 2013/2014 ?)
- Vacuum system (for coated chamber)
- 200 MHz RF system, beam control,
- transverse damper low-level control

Plus for PS2

- More RF power, cavities, beam control
- Transverse damper
- Beam dump (TIDVG)
- Dump kickers (MKDV/H), injection kickers (MKP)
- Beam collimation
- Radioprotection
- Beam instrumentation

Summary

- **Main SPS limitations for ultimate intensity** have been identified, measures to overcome them are under study (limited by resources)
- Machine development (MD) sessions with **higher than nominal intensity** needed to see other possible limitations (obtained by scaling so far)
- Recent work in the SPSU SG is mainly concentrated on **e-cloud mitigation**, a-C coating of vacuum chamber is the best candidate for implementation
- **The SPS RF system upgrade is required** for ultimate intensities, also reduces pressure for installation of the capture system in LHC
- e-cloud mitigation, impedance reduction and RF upgrade would help for **nominal and ultimate LHC beam** operation and can be implemented earlier
- In the upgrade plan with PS2, the SPS will have a higher injection energy which helps to overcome some high intensity limitations (single bunch, injection losses) and avoid transition crossing for CNGS/FT beam. Needs many studies and hardware modifications.

Spare slides

Nominal LHC cycle in the SPS

200 MHz voltage program

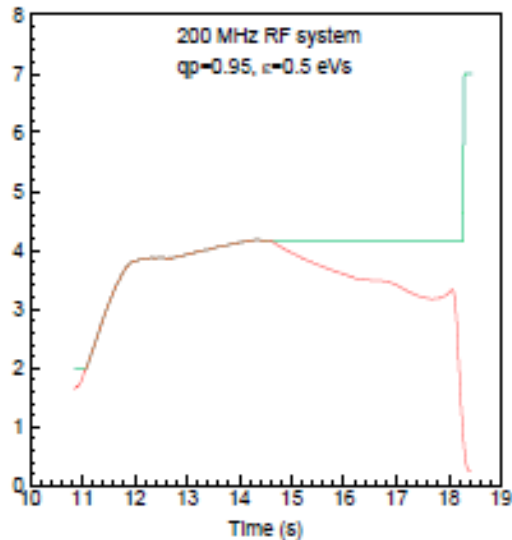

Beam stability (R_{sh} [M Ω m]) through the cycle in single and double RF

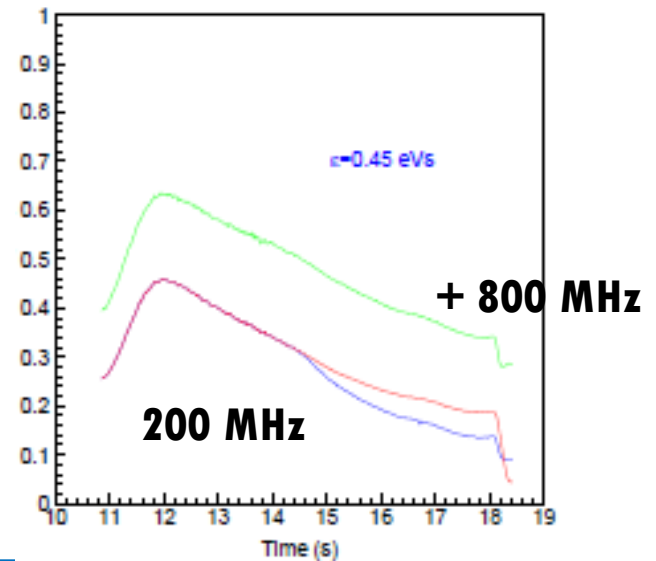

- Voltage for acceleration of the nominal LHC beam is well below limit except on flat top
- Flat top – transfer to 400 MHz LHC RF

200 MHz RF system for higher intensities – where?

in LHC

- 8 bare cavities exist plus tuners and HOM damping loops from the SW 200 MHz ; we have a low power coupler
- two identical systems (4 cavities/beam) → cost, maintenance
- reduce reliability
- no access during operation
- partial solution: beam still needs to be transferred to the 400 MHz RF system
- increase LHC impedance
- significantly (factor 4) reduce beam stability unless used with the 400 MHz RF system as a Landau cavity

in SPS

- rearrange existing 4 cavities into 5 or 6 cavities of shorter length with 1 or 2 extra power plants to
 - reduce beam loading per cavity
 - increase available voltage (~number of cavities)
 - reduce beam coupling impedance
 - accessible on the surface
- necessary first step for further intensity increase in the SPS (with PS2 as injector)

SPSU budget in 2008-2012

Year	2008	2009	2010	2011	2012	Total
allocated (kCHF)	333	187	200	200	180	1100
spent (kCHF)	339	188	10			

Plus 10 man-years were foreseen

2008:

- SPS set-up for e-cloud tests
- samples, SEY measurements +UHV
- coating system design
- C-magnets, cables
- clearing electrodes, grooves
- PhD student (1/2 year)

2009:

- SPS set-up for e-cloud tests
- samples , SEY measurements
- coating system
- 3 SPS magnet coating & installation
- microwave diagnostics, cables

2010:

- coating system development: 234 kCHF
- residual gas analyser, calorimeter: 31 kCHF
- ...